

0 29986191390 6

9139096

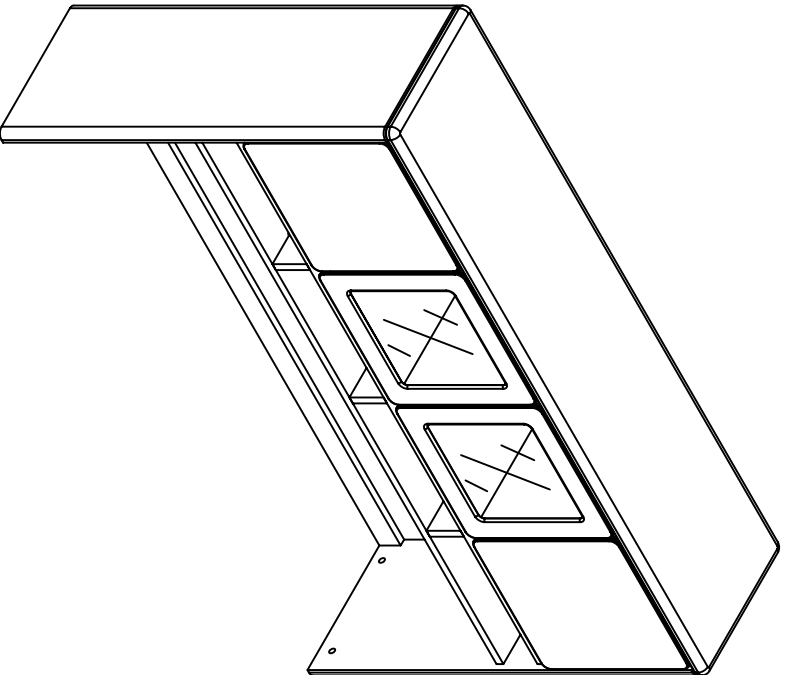

**THIS INTRUCTION BOOKLET CONTAINS
IMPORTANT SAFETY INFORMATION. PLEASE
READ AND KEEP FOR FUTURE REFERENCE.**

Spanish translations are located in the center of this manual,
Se localizan las traducciones españolas en el centro de este manual.

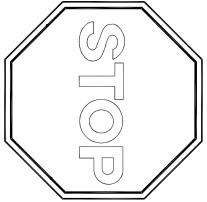

DO NOT RETURN PRODUCT TO THE STORE
Individual stores do not stock parts.

Lot Number: _____

Date of Purchase: ____/____/____

If a part is missing or damaged, call our toll-free customer service line. We will gladly ship your replacement parts FREE of charge.

Need Parts or Assistance?

1-800-489-3351

or access our website

@ www.altrafurniture.com

For prompt, reliable service please have your assembly manual ready.

Recommended # of people needed for assembly: 1
(however it is always better to have an extra hand.)
Estimated assembly time is 30 minutes.

B34913909600

Sep 13th, 2008

Thank you for purchasing from ALTRAFURNITURE.

Visit www.altrafurniture.com to view the limited warranty valid in the U.S. and Canada.

BEFORE STARTING

- Read each step carefully before starting. It is very important that each step of instruction is performed in the correct order. If these steps are not followed in sequence, assembly difficulties will occur.
- Make sure all parts are included. Most board parts are labeled or stamped on the raw edge.
- Work in spacious area, preferably on a carpet, near the place the unit will be used.
- Have the following tools close at hand.
- Do not use power tools to assemble your furniture. Power tools may strip or damage the parts.

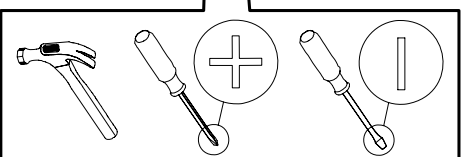

HELPFUL HINTS

- Visit our website for assembly video clips.
- Call our toll free number if you need assistance.
- Compression dowels are tapped in with a hammer.
- Back panels provide stability and support. Use all the nails provided. Units without the back panel installed may collapse.
- When tapping nails into a board, be sure there are equal margins on all side to square the unit.
- Move your new furniture carefully, with two people lift and carry the unit to it's new location.
- Never push, drag or scoot your furniture (especially on carpet).
- Your ALTRA furniture can be disassembled and reassembled to move
- Additional parts are available for a nominal fee.

For help with assembly, identifying parts, product information or to order parts, please contact us:



Call us at: 1-800-489-3351

Monday-Friday
7:00 am - 8:00 pm
Saturday
9:00 am - 5:00 pm
(Central Time)



FAX:

1-636-745-1005

available 24 hours a day,
7 days a week

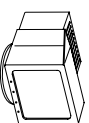

Visit our website:

www.altrafurniture.com



Write to:

ALTRAFURNITURE
P.O. Box 346
Wright city, MO 63390 USA
Attention: Service Dept.

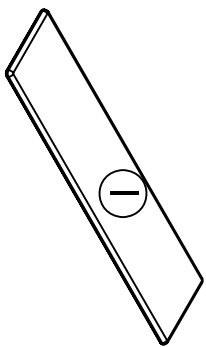

Hutch Top Panel
T9139096050

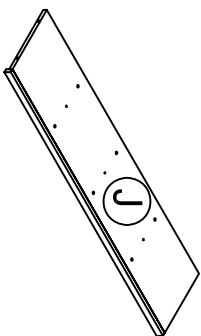

Fixed Shelf
T9139096060

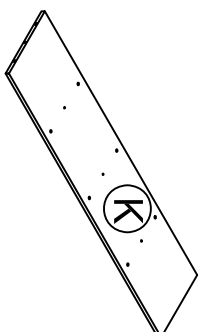

Shelf
T9139096070

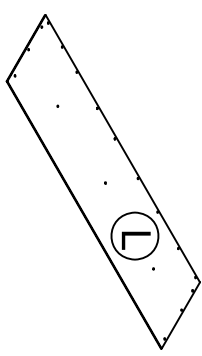

Upper Back Panel
T9139096080

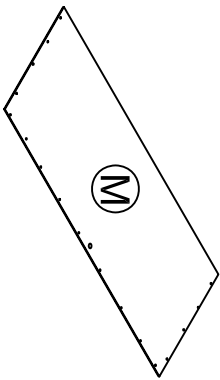

Lower Back Panel
T9139096090

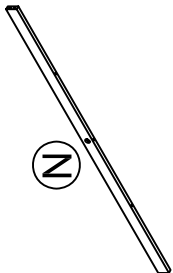

Lower Rail
T9139096100

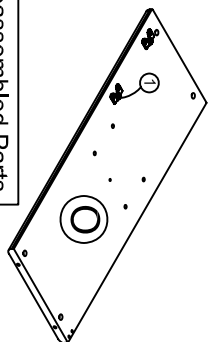

Left Side Panel
T9139096110

Preassembled Parts
Left Side Panel T9139096111
Ø3*15mm Screw TWP0009
(1)Hinge Chassis TWP0030

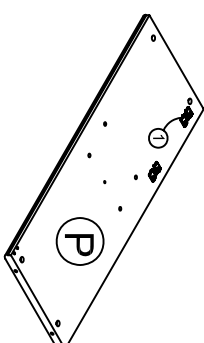

Right Side Panel
T9139096120

Preassembled Parts
Right Side Panel T9139096121
Ø3*15mm Screw TWP0009
(1)Hinge Chassis TWP0030

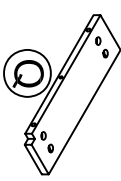

Middle Panel (3)
T9139096130

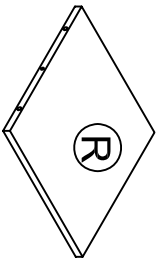

Middle Partition Panel
T9139096140

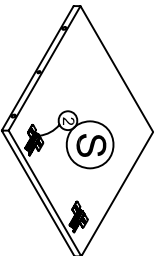

Left Partition Panel
T9139096150

Preassembled Parts
Left Partition Panel T9139096151
Ø3*15mm Screw TWP0009
(2)Hinge Chassis TWP0031

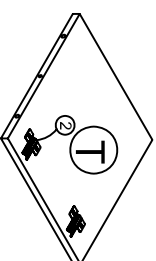

Right Partition Panel(2)
T9139096160

Preassembled Parts
Right Partition Panel T9139096161
Ø3*15mm Screw TWP0009
(2)Hinge Chassis TWP0031

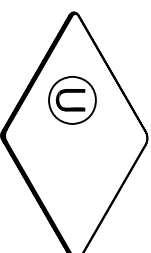

Wood Door
T9139096170

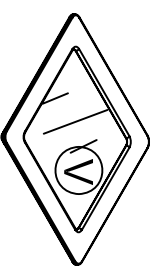

Glass Door(2)
T9139096180

Preassembled Parts
Glass Door T9139096181
Glass T9139096182
Plastic Bar T9139096183

This illustration shows how the CAM fastening system works.

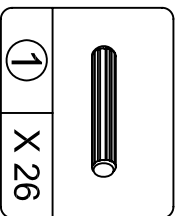

Ø6*30mm Wood Dowel
TWP0001

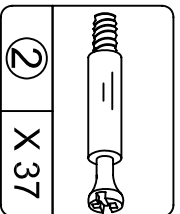

Ø6.3*36mm Cam Bolt
TWP0002

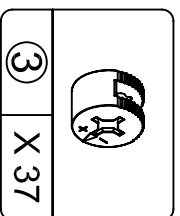

Ø15*9mm Cam Lock
TWP0003

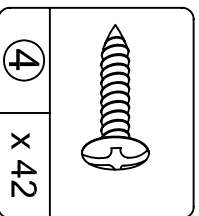

Ø3*12mm Pan head
TWP0007

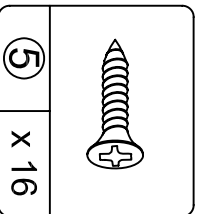

Ø3*15mm Screw
TWP0009

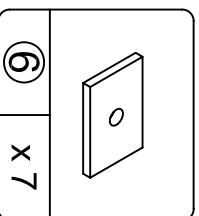

10*17mm Square
metal plate
TWP0011

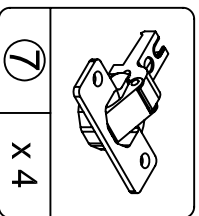

Hinge
TWP0030

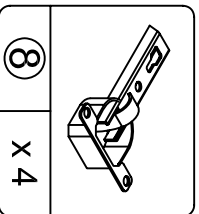

Hinge
TWP0031

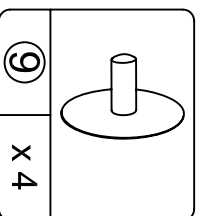

Ø18*8.5mm Cam cover
TWP0004

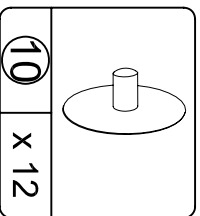

Ø18*7mm Cam cover
TWP0005

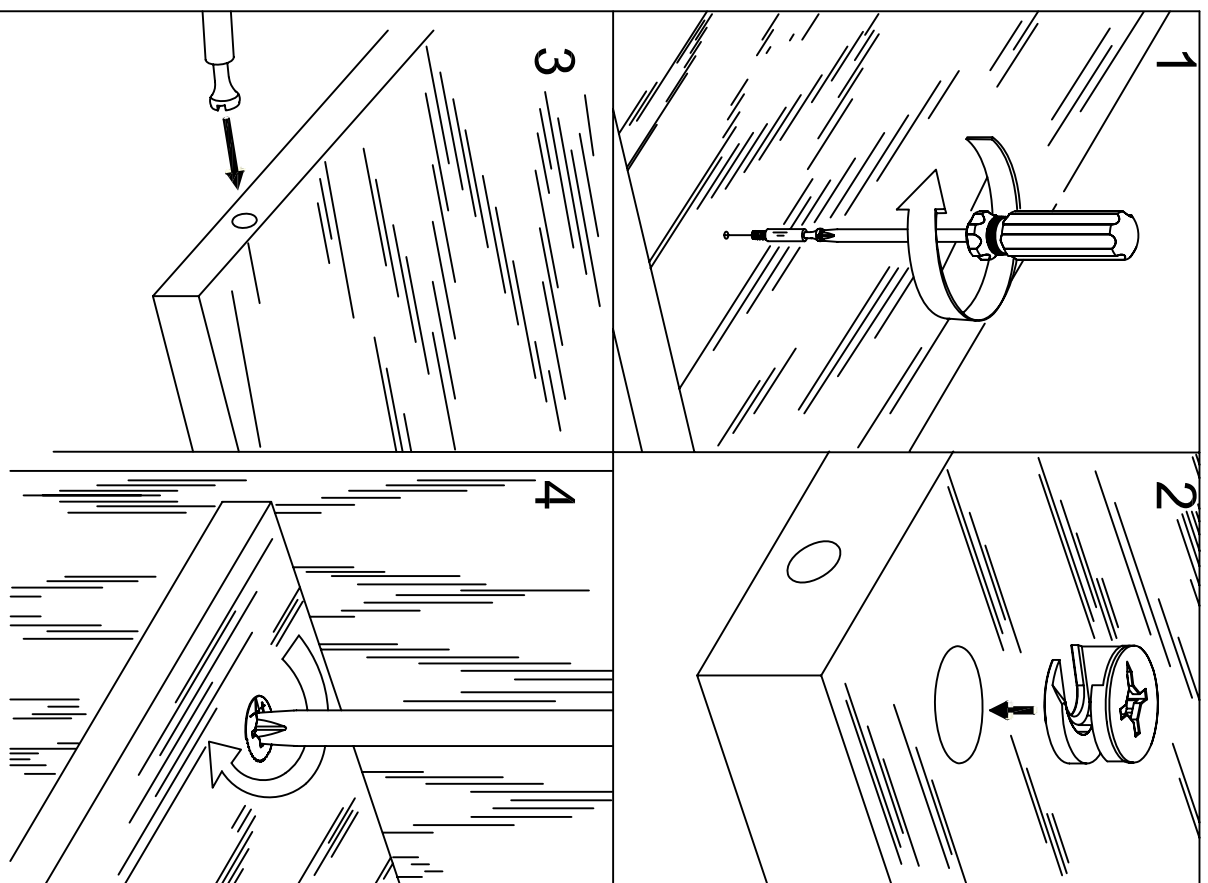

- 1 -Insert 3 wood dowels(1) into the holes of shelf(K) as shown.
-Screw 6 cam bolts(2) into the holes of shelf(K) as shown.

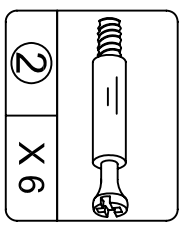
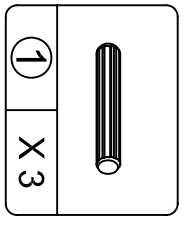
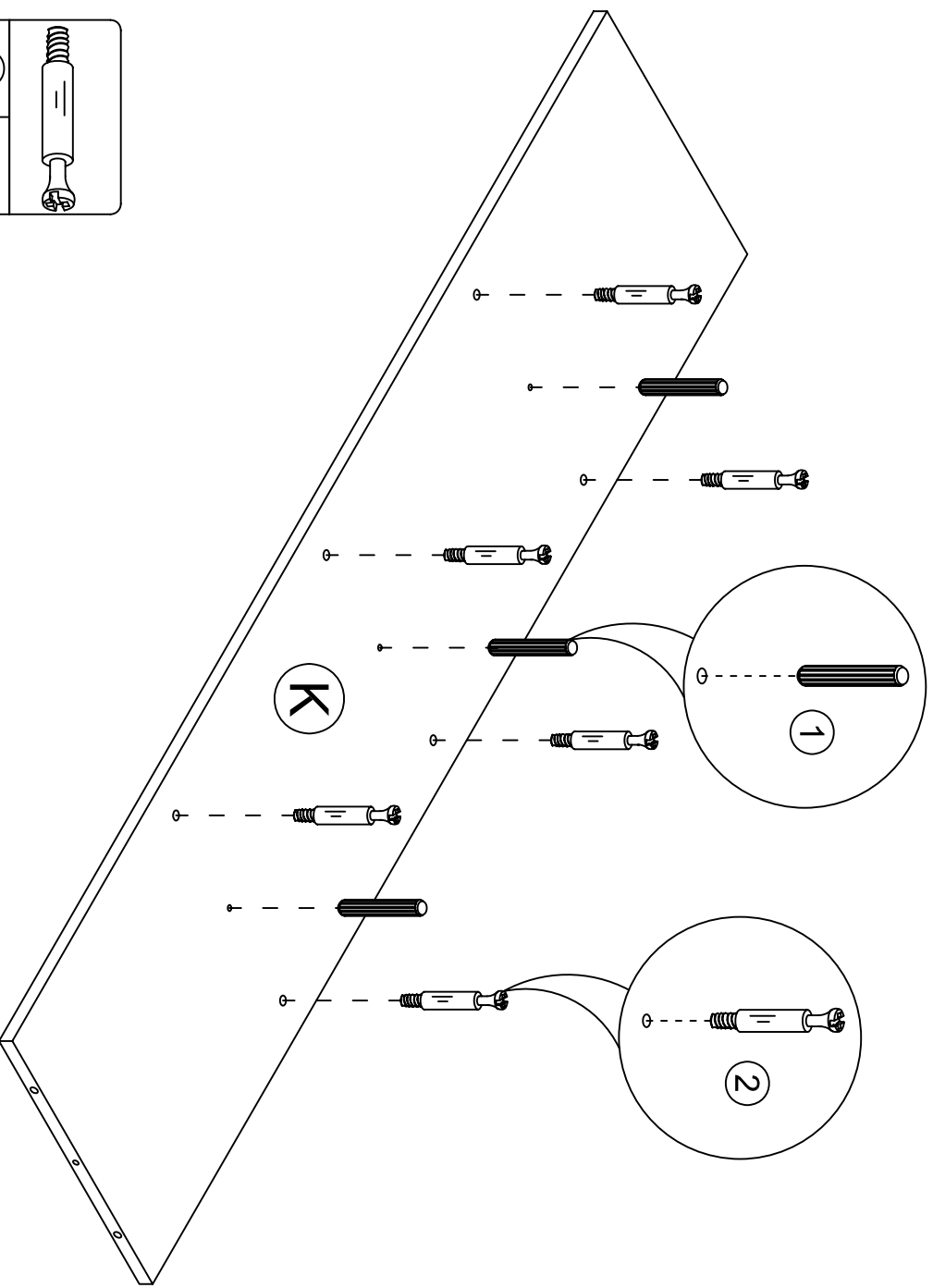

2 -Attach one shelf (K) to the middle panels (Q) with 6 cam locks (3) 6 cam covers(10) as shown.

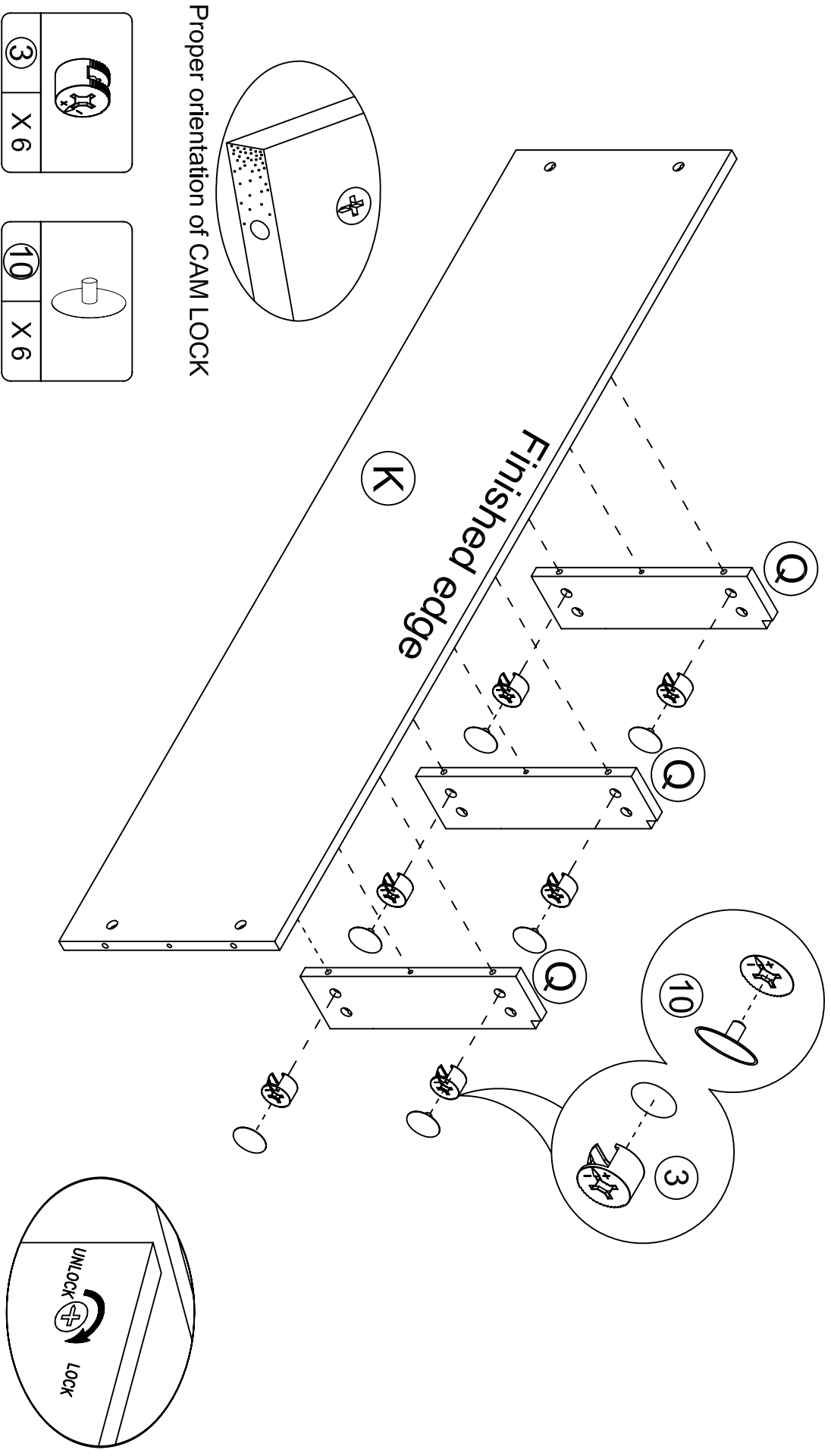

- 3** -Insert 3 wood dowels(1) into the holes of fixed shelf(J) as shown.
-Screw 6 cam bolts(2) into the holes of fixed shelf(J) as shown.

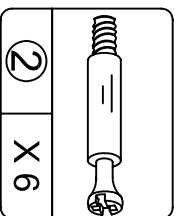
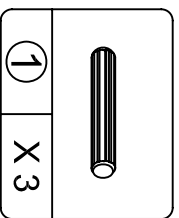
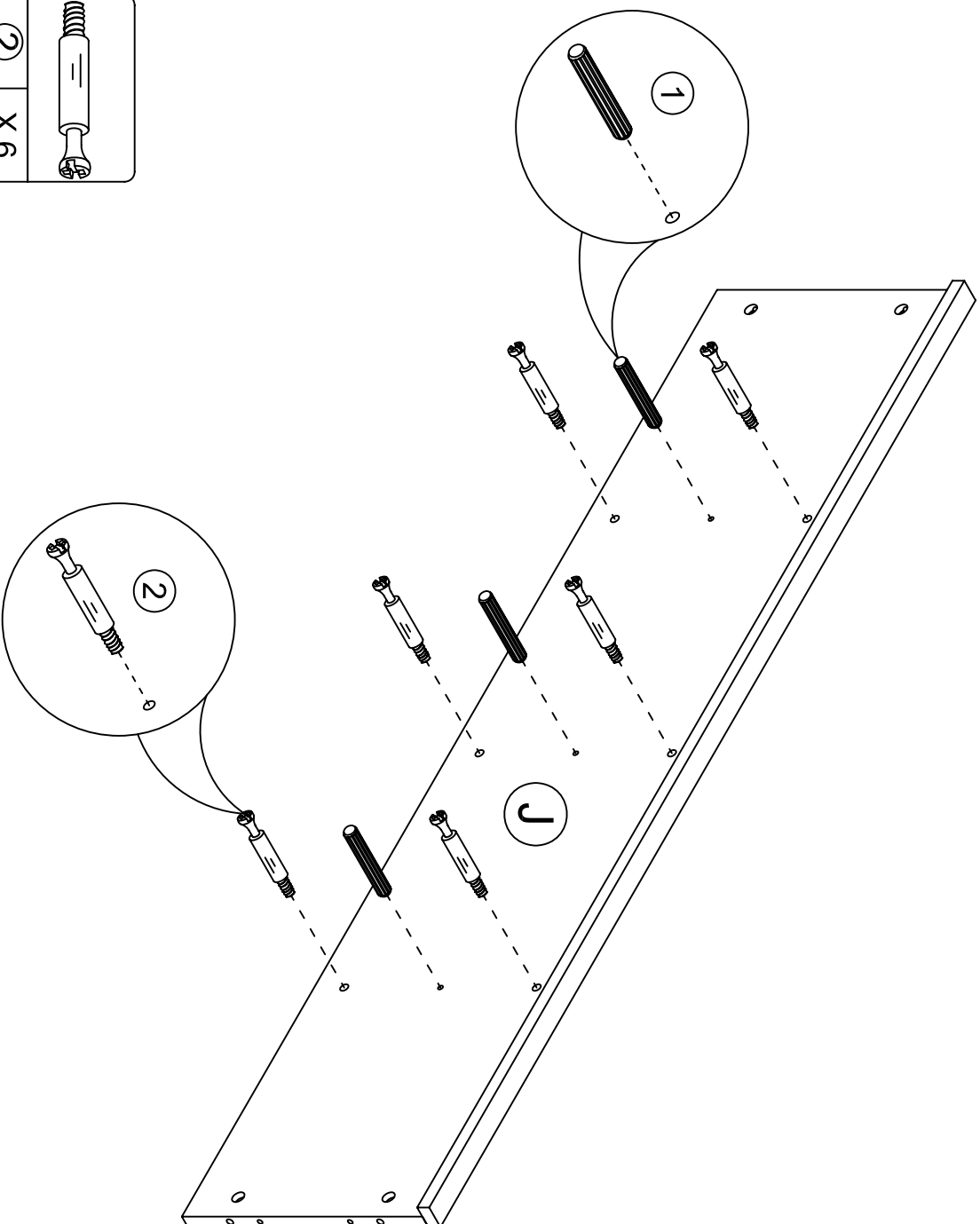

4 -Attach one fixed shelf (J) to the middle panels (Q) with 6 cam locks (3) 6 cam covers(10) as shown.

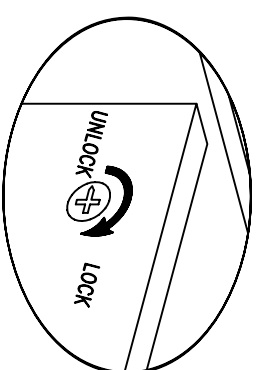
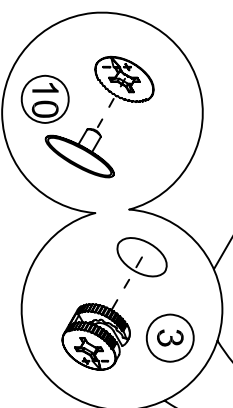
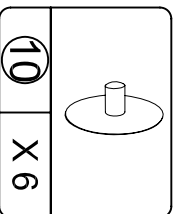
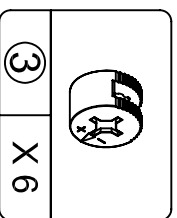
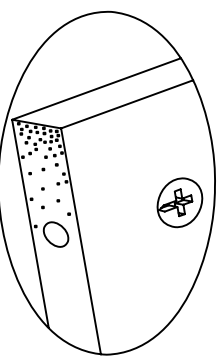
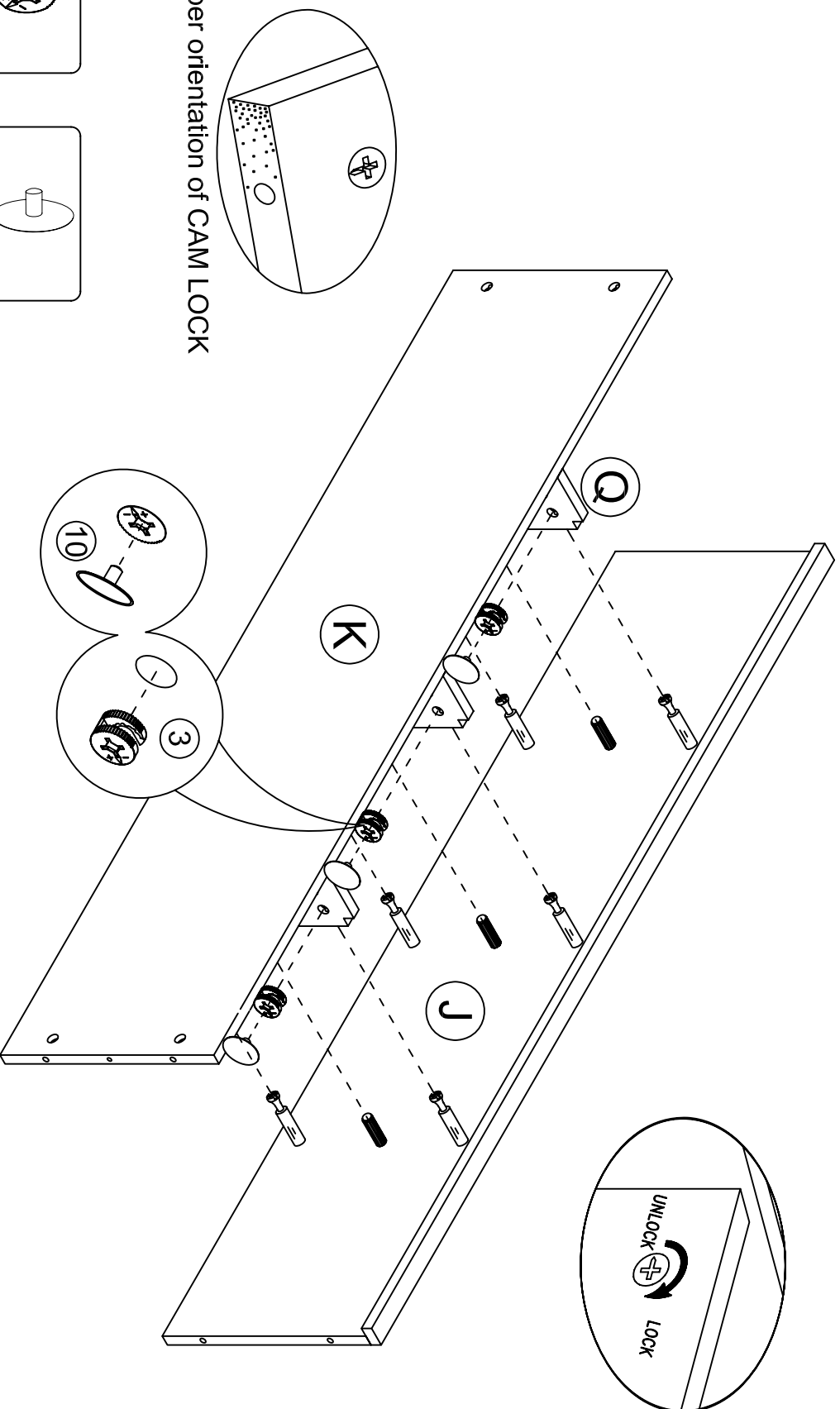

- 5** -Insert 3 wood dowels(1) into the holes of fixed shelf(J) as shown.
-Screw 6 cam bolts(2) into the holes of fixed shelf(J) as shown.

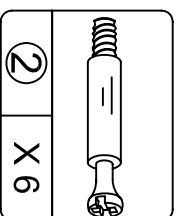
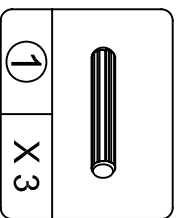
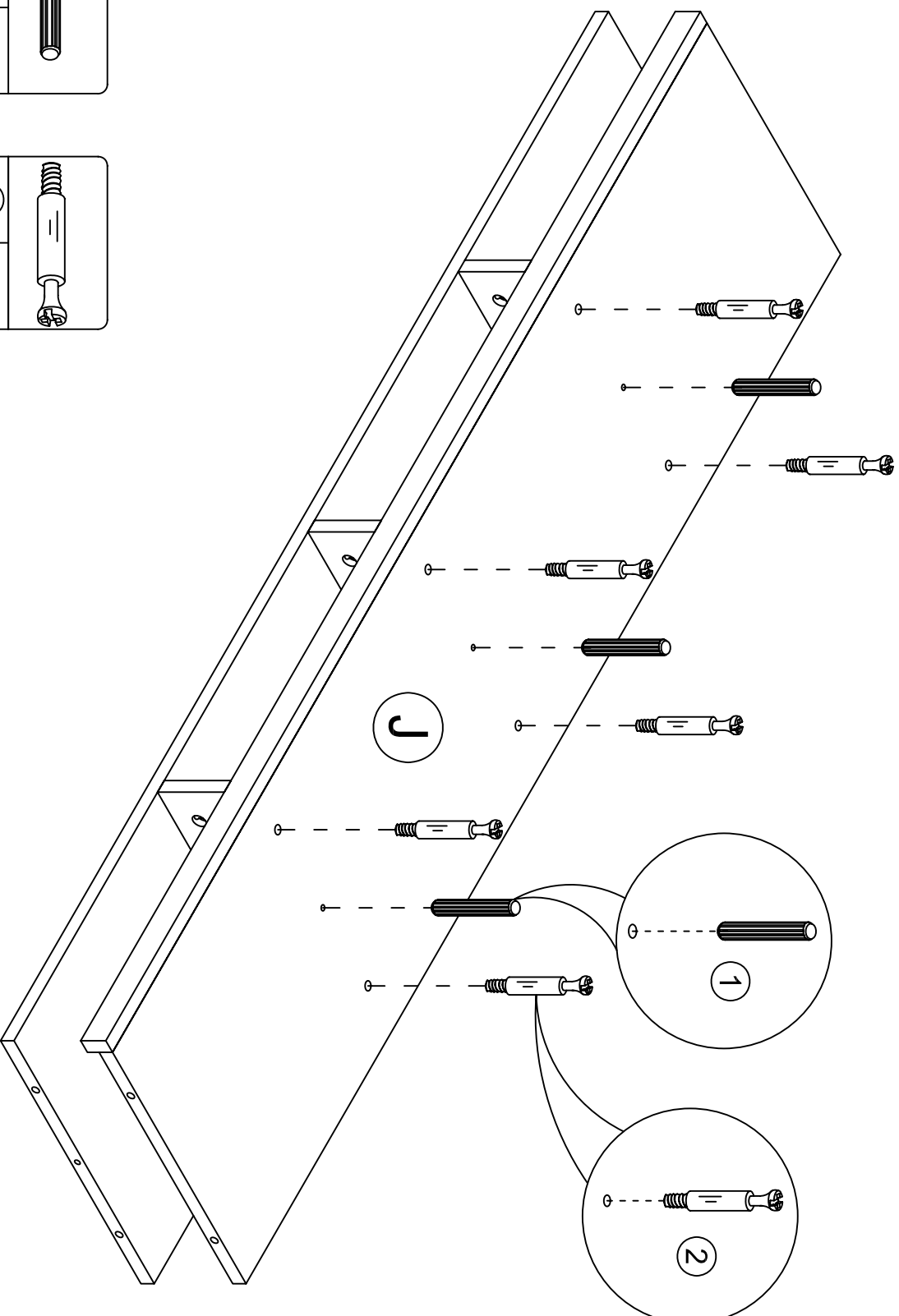

6 -Attach one left partition panel (S) right partition panel (T) and middle partition panel (R) to the fixed shelf (J) with 6 cam locks (3) as shown.

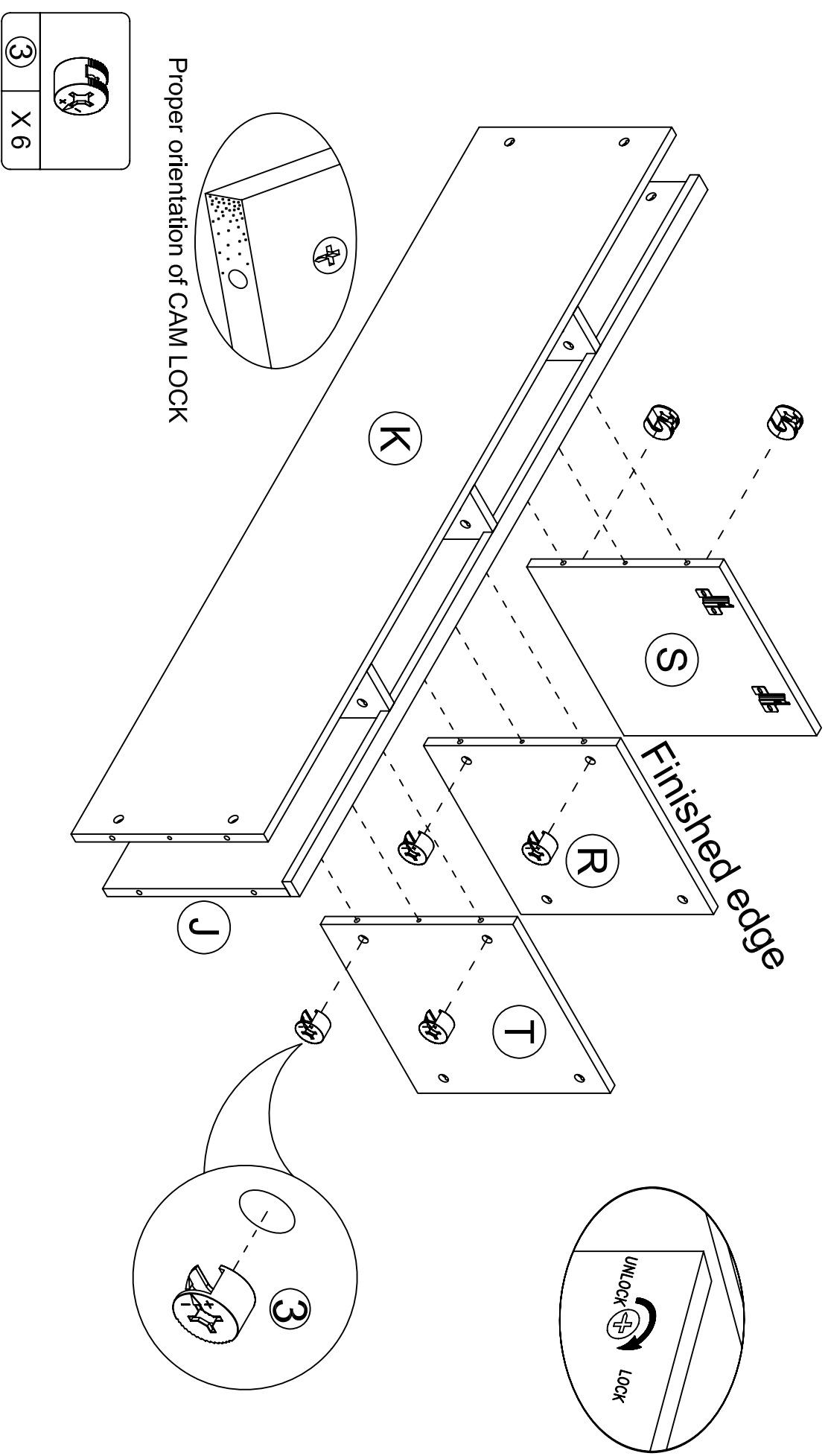

- 7** -Insert 10 wood dowels(1) into the holes of side panels(O&P) as shown.
-Screw 4 cam bolts(2) into the holes of side panels(O&P) as shown.

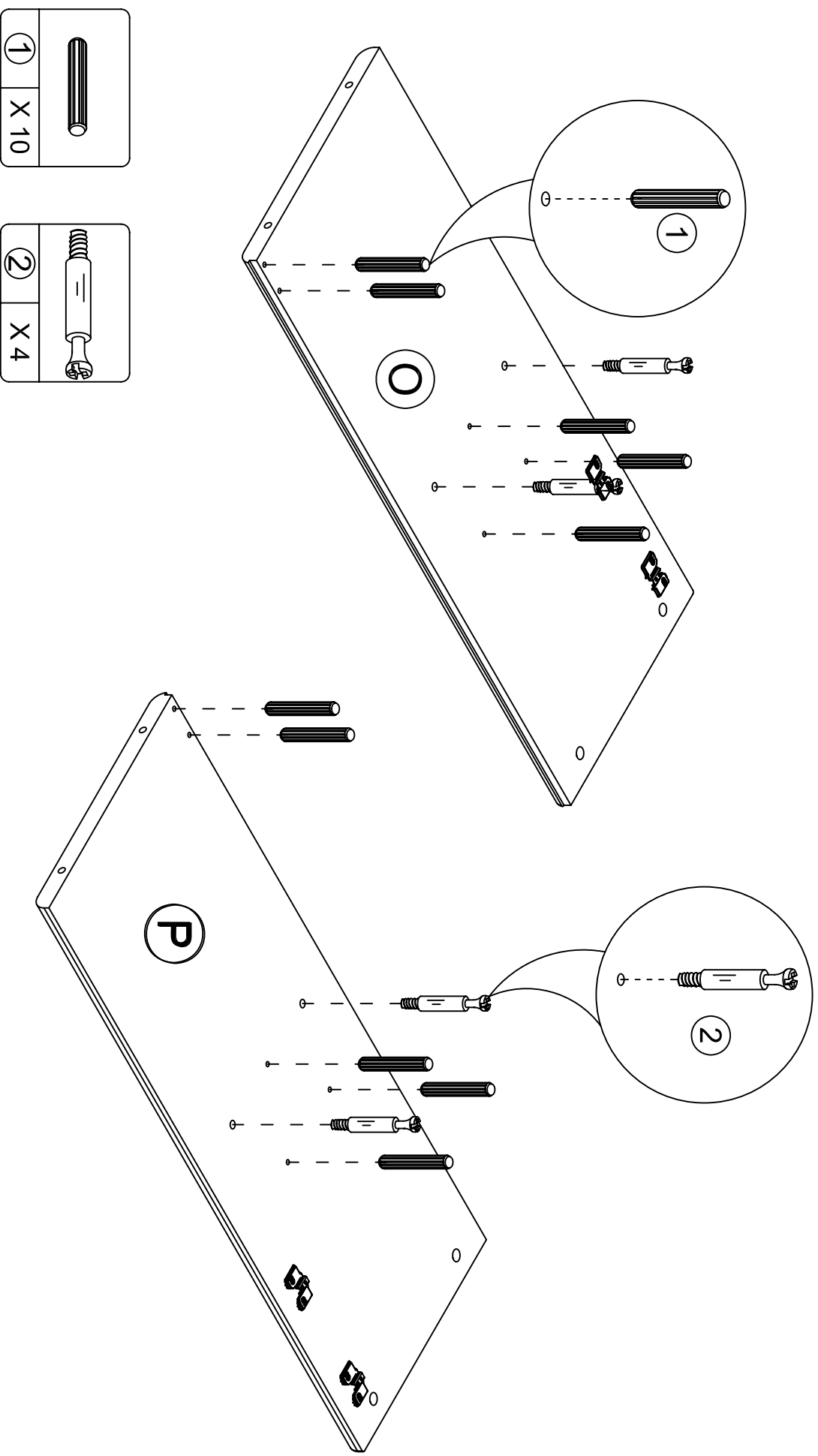

8 -Attach two side panels(O&P) to the fixed shelves(J&K) and lower rail (N) with 4 cam locks (3) as shown.

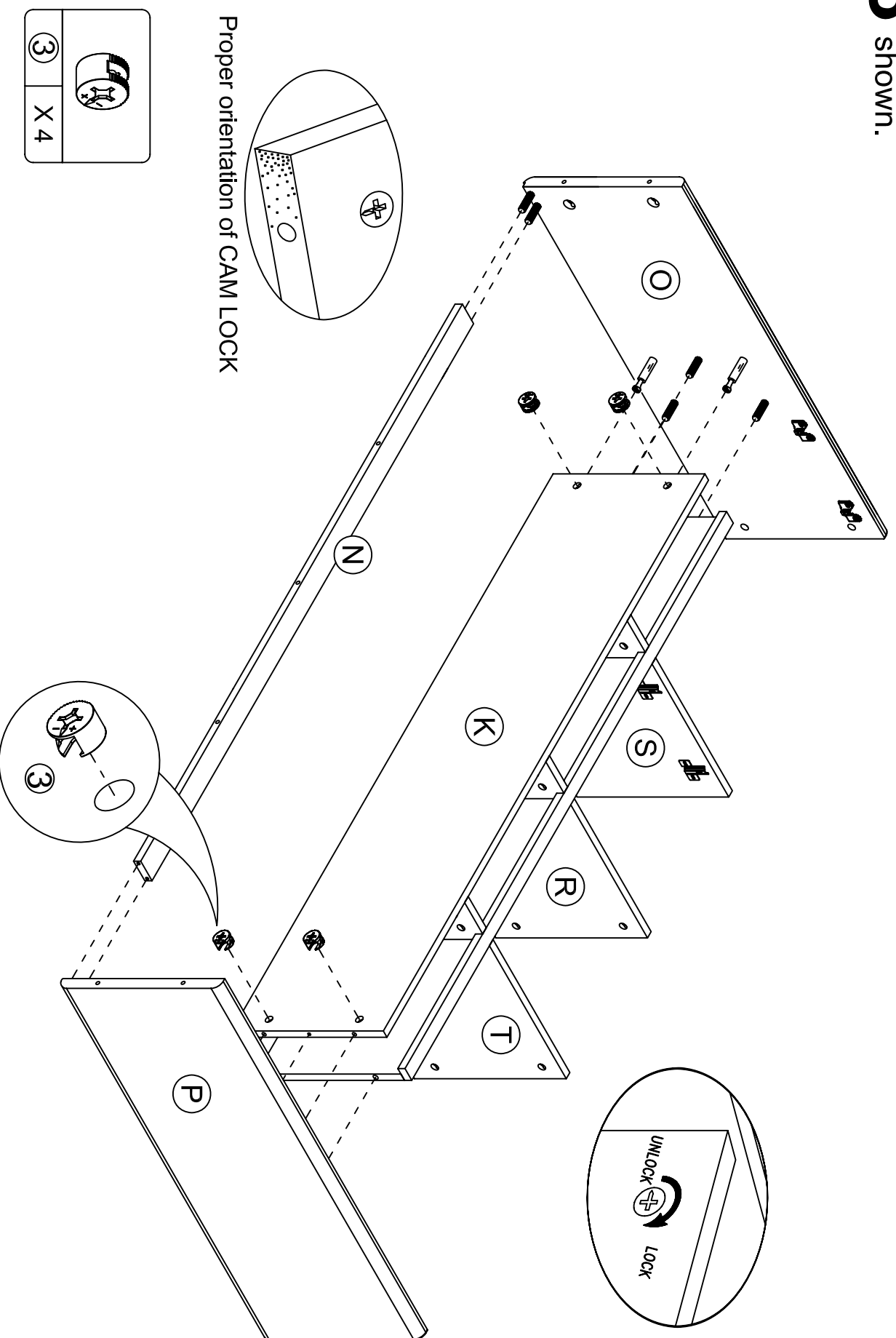

12/21

- 9** -Insert 5 wood dowels(1) into the holes of top panel(1) as shown.
-Screw 10 cam bolts(2) into the holes of top panel(1) as shown.

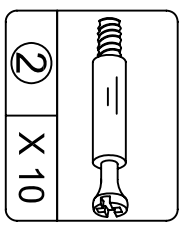
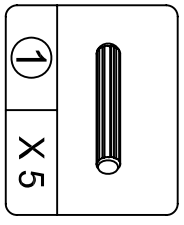
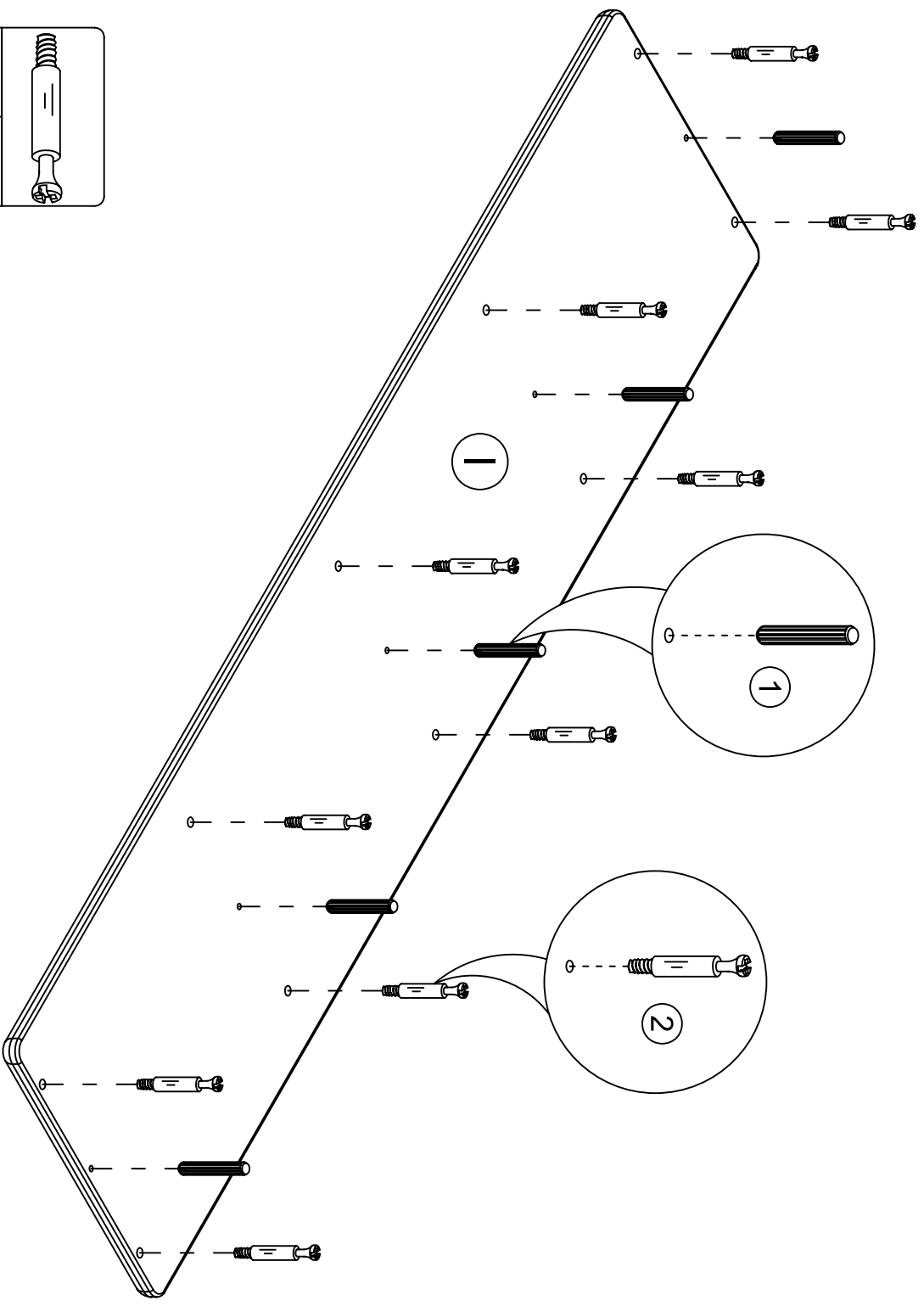

10

-Attach one top panel (I) to the side panels (O&P) and partition panels (S&R&T) with 10 cam locks (3) as shown.

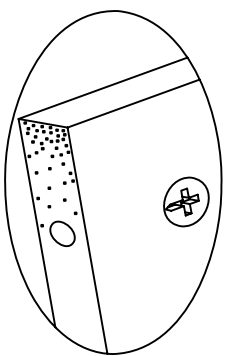

Proper orientation of CAM LOCK

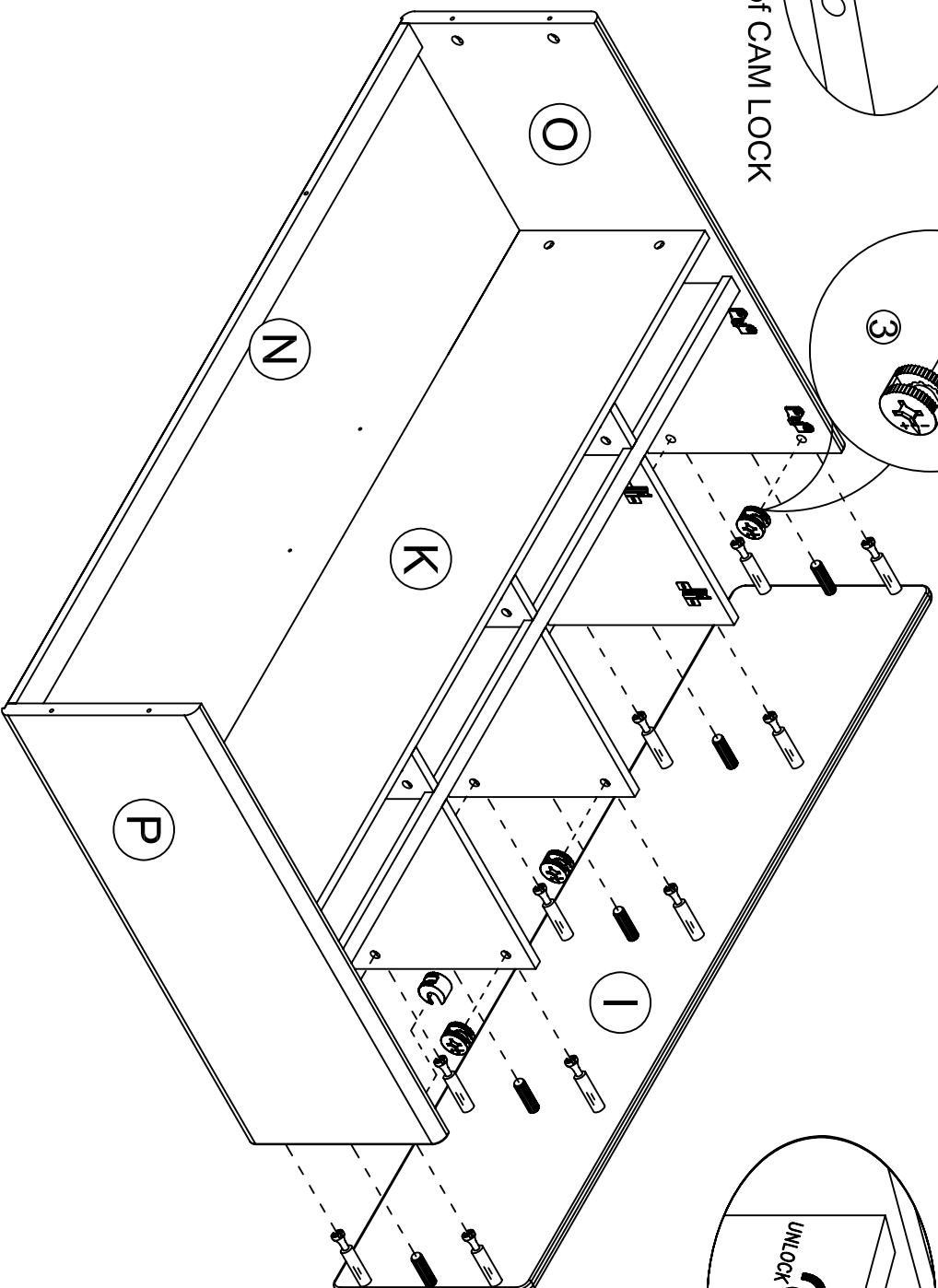
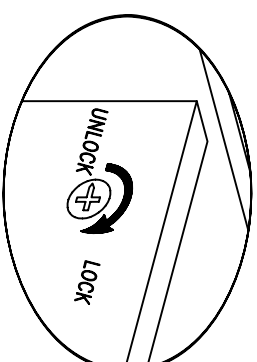
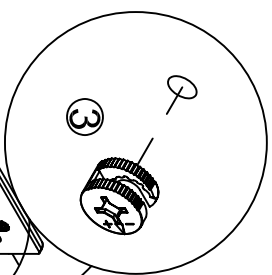

③	X 10

11

-Screw two back panels (L&M) to the frame with 35 screws (4) as shown.

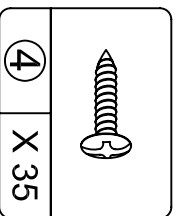
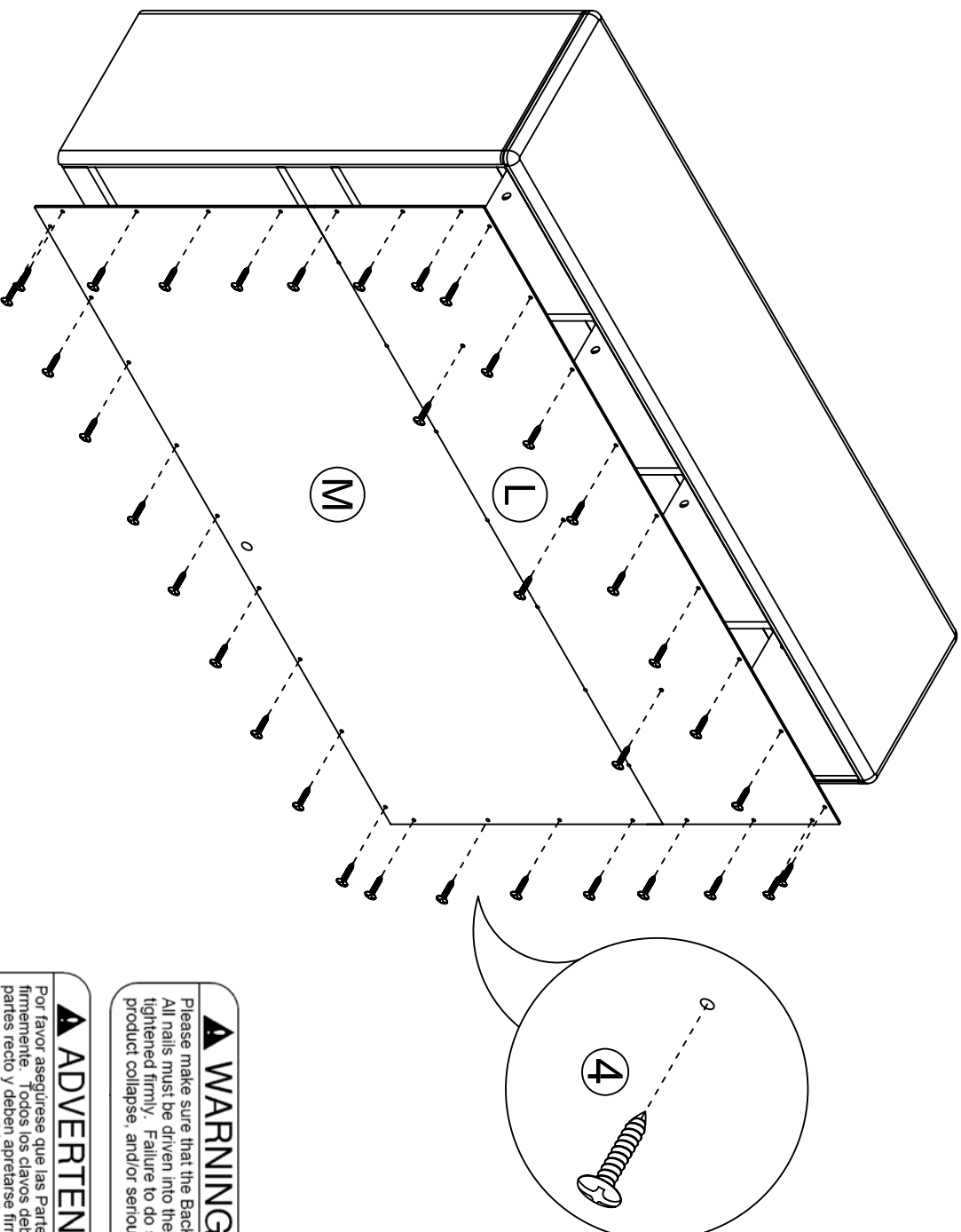

▲ WARNING
Please make sure that the Back Panel is attached securely. All nails must be driven into the parts straight, centered and tightened firmly. Failure to do so could cause instability, product collapse, and/or serious injury.

▲ ADVERTENCIA
Por favor asegúrese que las Parte de atrás se atan firmemente. Todos los clavos deben manejarse en las partes recto y deben apretarse firmemente. El fracaso para hacer para que podría causar inestabilidad, derrumbamiento del producto, y/o la lesión seria.

12

-Screw two back panels (L&M) to the frame with 7 screws (4) and 7 square metal plates (6) as shown.

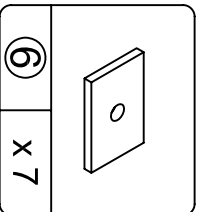
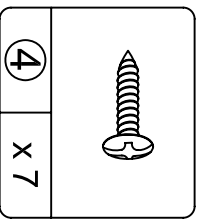
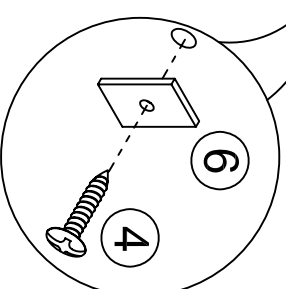
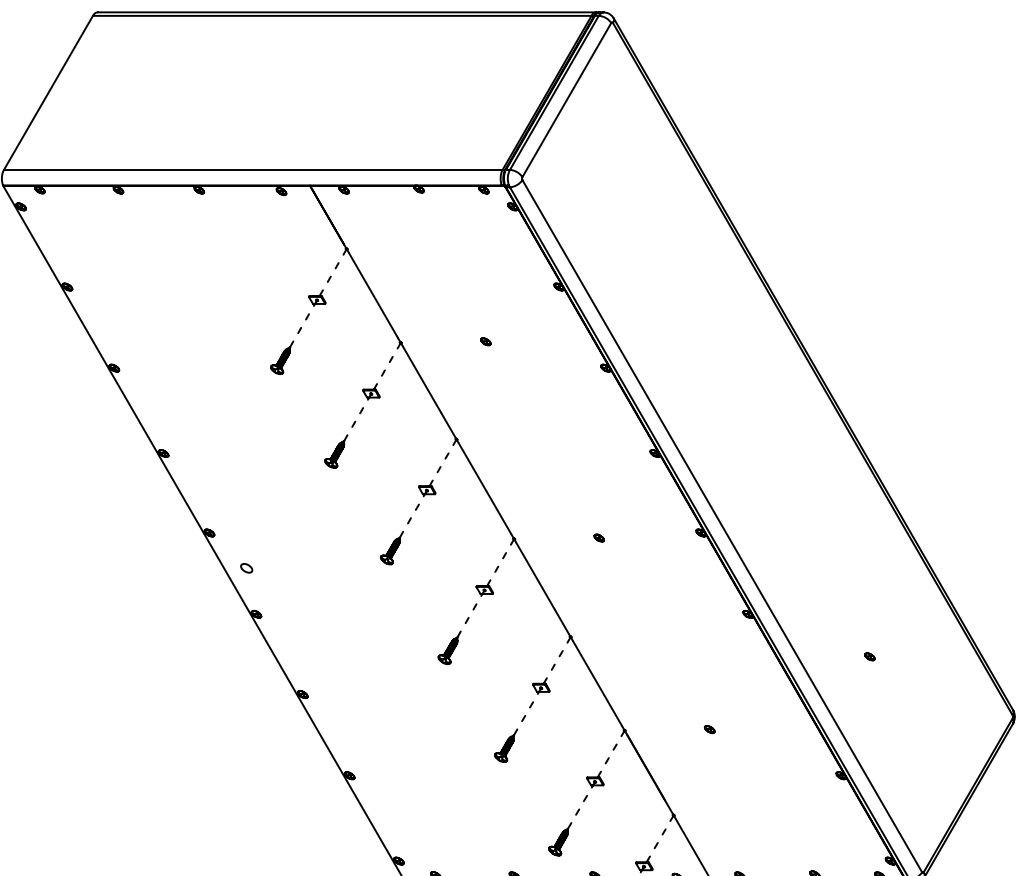

▲ WARNING

Please make sure that the Back Panel is attached securely. All nails must be driven into the parts straight, centered and tightened firmly. Failure to do so could cause instability, product collapse, and/or serious injury.

▲ ADVERTENCIA

Por favor asegúrese que las Parte de atrás se atan firmemente. Todos los clavos deben manejarse en las partes recto y deben apretarse firmemente. El fracaso para hacer para que podría causar inestabilidad, derrumbamiento del producto, y/o la lesión seria.

13

- Attach two hinges (7) to the wood door(U) with 8 screws (5) as shown.
- Attach two hinges (8) to the glass door(V) with 8 screws (5) as shown.

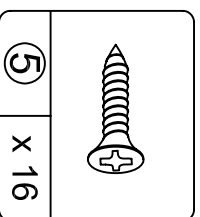
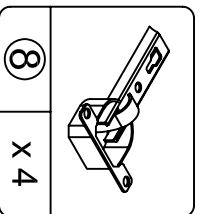
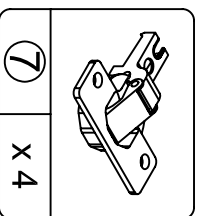
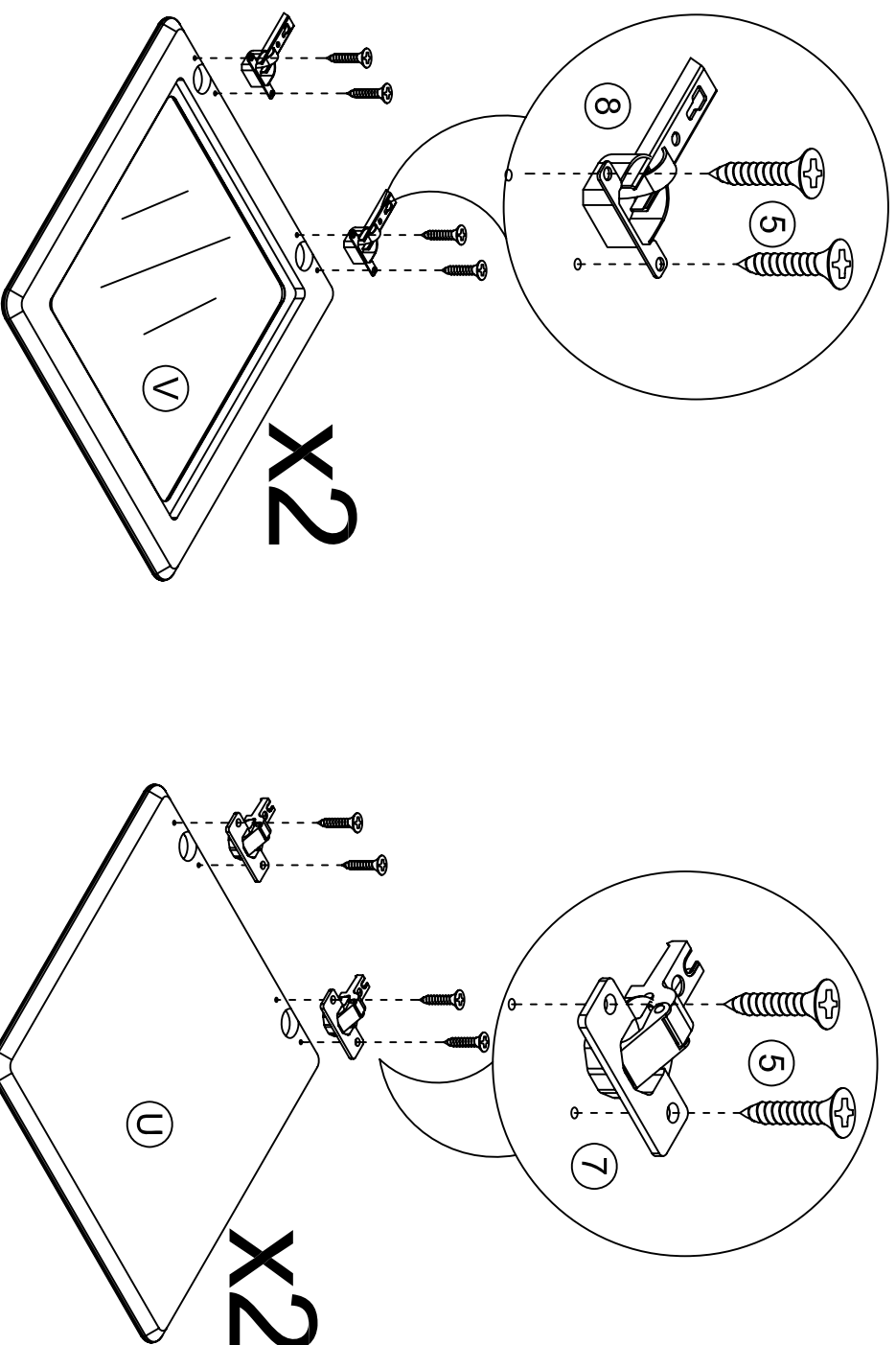

14

- Attach two wood doors (U) to the side panels (O&P) as shown.
- Attach two glass doors (V) to the partition panels (S&T) as shown.

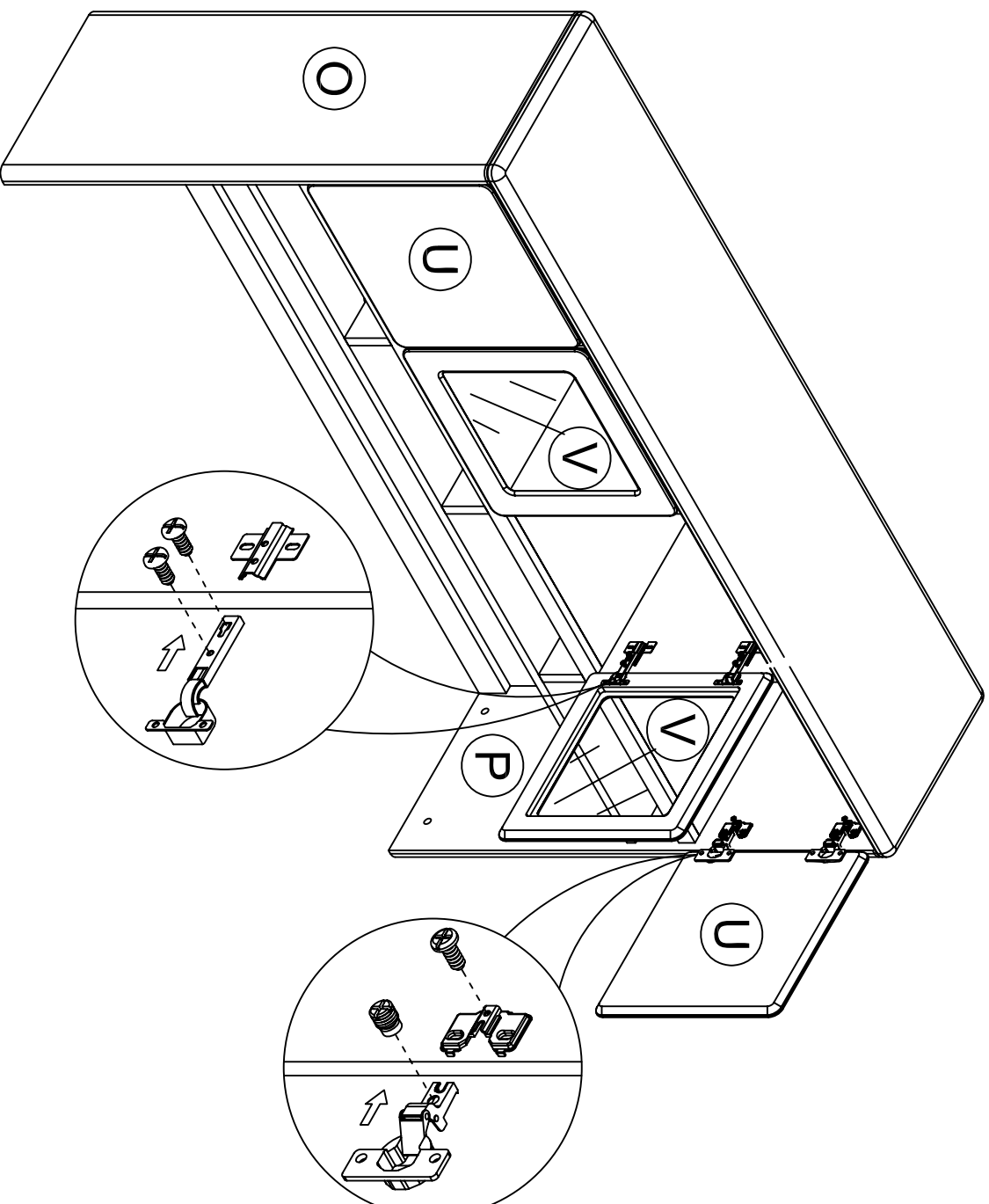

18/21

???.www.altrafurniture.com???

B34913909600

15

-Insert 2 wood dowels(1) into the holes of Credenza top panel as shown.
-Screw 5 cam bolts(2) into the holes of Credenza top panel as shown.

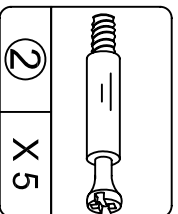
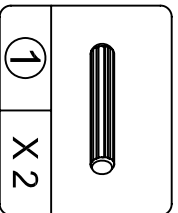
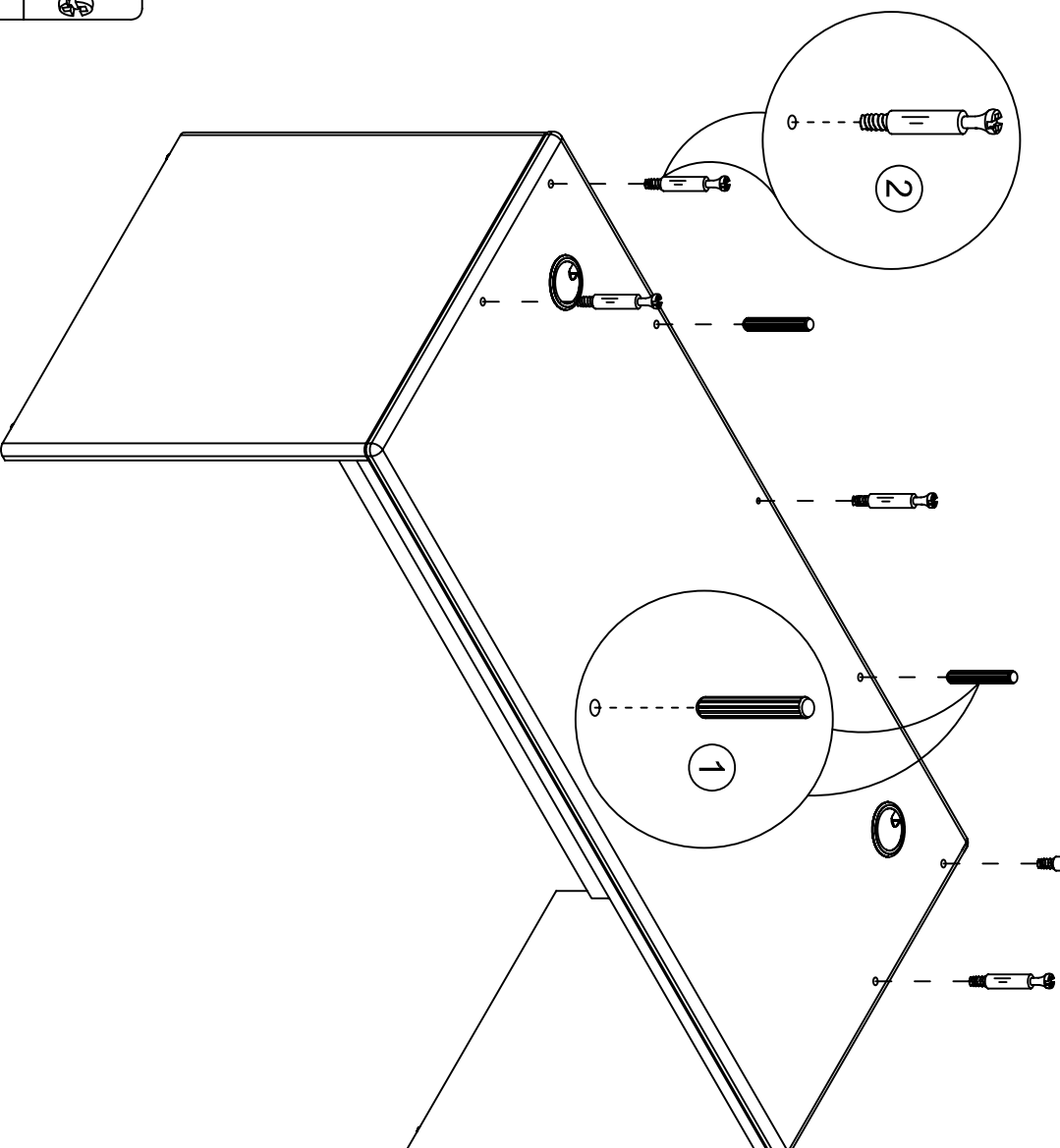

16

-Place the hutch on the Credenza with 5 cam locks (3) 4 cam covers (9) as shown.

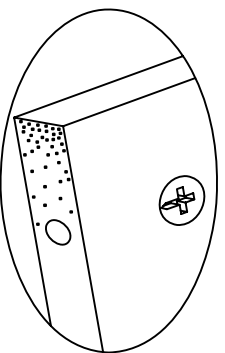

Proper orientation of CAM LOCK

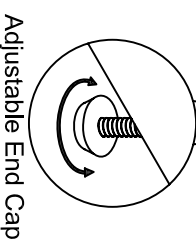
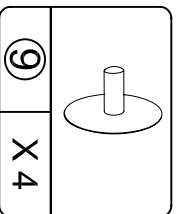
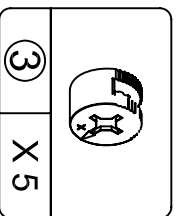
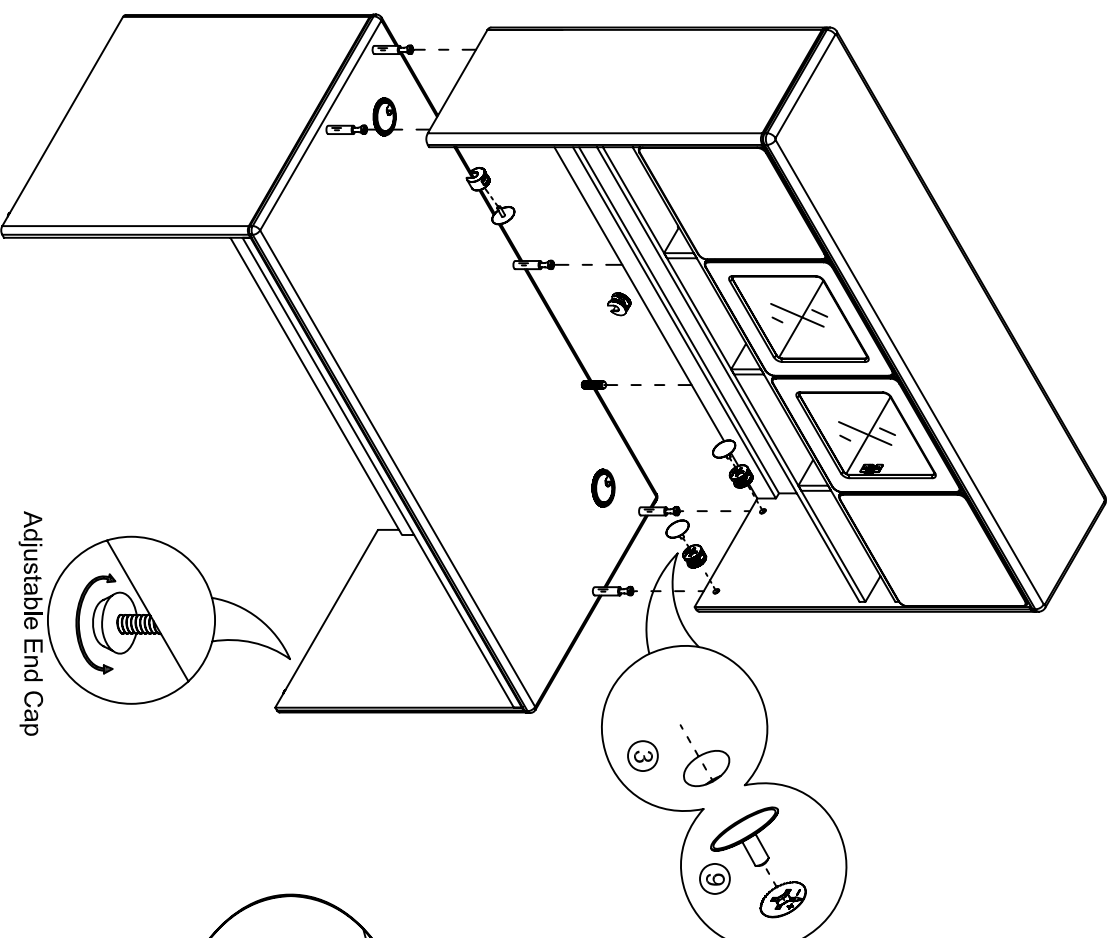

Adjustable End Cap

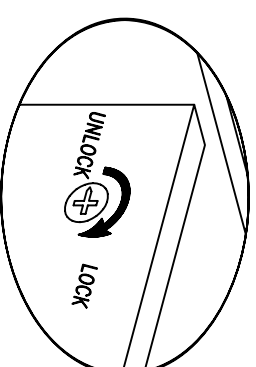

Call our toll free number for any assistance you should need or visit our website:

1-800-489-3351

www.altrafurniture.com

Weight Limits:

Clean the product with your favorite furniture polish and a soft cloth. **DO NOT USE** harsh chemicals or abrasive cleaners.

Move your new furniture carefully with two people. Lift and carry the unit. Never push or drag the unit.

DO not allow children to climb or play on the unit.
Failure to comply could result in severe injury.

This unit has been designed to support the maximum loads shown. Exceeding these load limits could cause unit sagging, instability, product collapse and/or serious injury.

Additional parts are available for a nominal fee.

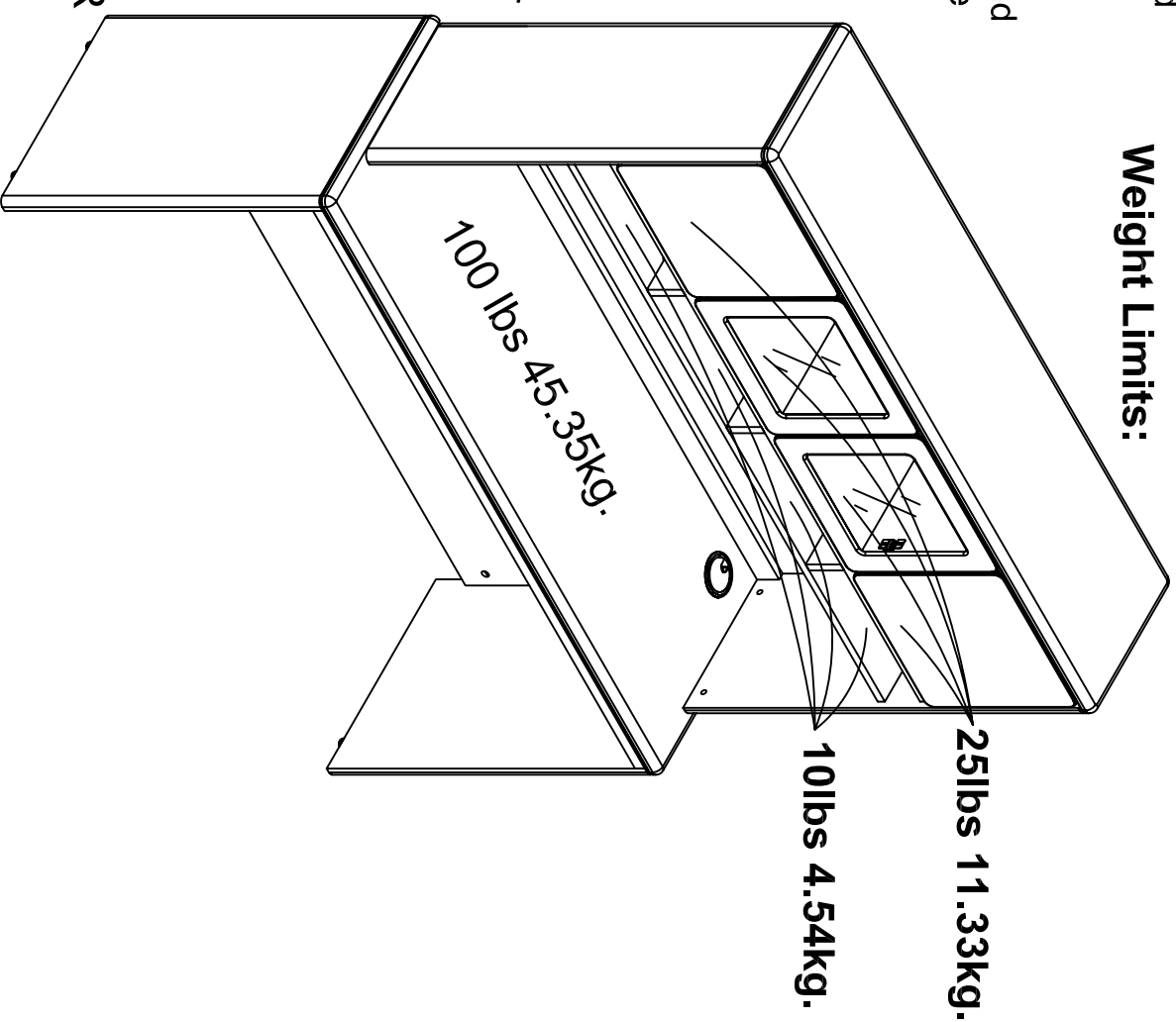

Enjoy Your Furniture
PROFITEZ BIEN DE VOTRE MOBILIER
DISFRUTE DE SU MUEBLE



Call us at: 1-800-489-3351

Monday-Friday

7:30 am - 8:30 pm

Saturday

9:30 am - 5:00 pm

(Central Time)



FAX:

1-636-745-1005

available 24 hours a day,

7 days a week



Visit our website:

www.altrafurniture.com



Write to:

ALTRAFURNITURE

P.O. Box 346

Wright city, MO 63390 USA

Attention: Service Dept.

9139096

No regrese el producto a esta tienda, tiendas individuales no almacenan partes.

Si le falta una parte o esta danada, llame al numero gratis a la lineas de servicio al cliente. Nosotros con gusto le mandaremos la parte sin ningun costo adicional.

El numero recomendado de las personas necesario para la asamblea: 1 (Sin embargo siempre es bueno tener una mano extra.) El tiempo de la asamblea estimado es 30 minutos.

EL FOLLETO DE LA INSTRUCCION CONTIENE LE INFORMACION DE SEGURIDAD IMPORTANTE. POR FAVOR LEA Y GUARDE PARA LA REFERENCIA FUTURA.

Número de porción: _____

Ferch de Compa: ____ / ____ / ____

ANTES DE EMPEZAR

- Lea cada paso cuidadosamente antes de empezar. Es muy importante que cada paso de instruccion haya realizado en el orden correcto. Si estos pasos no se siguen en la sucesión, las dificultades de la asamblea ocurrirán.
- Haga que todas las partes son incluido. Más partes de la tabla se etiquetan o estamparon en el borde crudo.
- El trabajo en una área espaciosa, preferentemente en una alfombra, cerca del lugar la unidad se usará.
- Tenga las herramientas siguientes cerrar a mano.
- No use las herramientas de poder para congrega su mobiliario. Las herramientas de Power pueden despojar o pueden dañar las partes.

LAS INDIRECTAS ÚTILES

- visite nuestro website para la asamblea las grapas videas.
- llame nuestro peaje el número libre si usted necesita la ayuda.
- Las clavijas de condensación se taladran en con un martillo.
- Los tableros del parte de atrás proporcionan estabilidad y apoyo. Use todas las uñas proporcionadas. Las unidades a menos que el tablero de la parte de atrás instalado puede derrumbarse.
- cuando taladrando las uñas en una tabla, esté seguro hay márgenes iguales en todos los lados cuadrar la unidad.
- El movedor su nuevo mobiliario cuidadosamente, con dos personas, alzamiento y lleva la unidad a él es la nueva situación.
- nunca empuje, arrastre o salga su mobiliario (sobre todo en la alfombra).
- su mobiliario de AMERIWOOD puede desmontarse y puede volverse a montar para mover.
- Las partes adicionales están disponibles para una cuota nominal.

LISTA DE PARTES

ITEM	DESCRIPCION	CANTIDAD
I	Panel de cima de conejera	1
J	Tablero fijo	1
K	Tablero	1
L	Panel trasero superior	1
M	Panel trasero inferior	1
N	Barra inferior	1
O	Panel lateral izquierdo	1
P	Panel lateral derecho	1
Q	Panel del centro	3
R	Particion del centro	1
S	Particion izquierdo	1
T	Particion derecho	1
U	Puerta de madera	2
V	Puerta de vaso	2

PASO 1	Inserte tres clavijas de madera (1) en los agujeros del tablero (K) como mostrado. Atornille seis pernos de la leva (2) en los agujeros del tablero (K) como mostrado.
PASO 2	Ate un tablero (K) a los paneles del centro(Q) con seis cerraduras de la leva (3) y seis tapas de la leva (10) como mostrado.
PASO 3	Inserte tres clavijas de madera (1) en los agujeros del tablero fijo (J) como mostrado. Atornille seis pernos de la leva (2) en los agujeros del tablero fijo (J) como mostrado.
PASO 4	Ate uno el tablero fijo (J) a los paneles del centro (Q) con seis cerraduras de la leva (3) y seis tapas de la leva (10) como mostrado.
PASO 5	Inserte tres clavijas de madera (1) en los agujeros del tablero fijo (J) como mostrado. Atornille seis pernos de la leva (2) en los agujeros del tablero fijo (J) como mostrado.

ITEM	DESCRIPCION	CANTIDAD
1	Clavija de Madera Ø6x30mm	26
2	Perno de la leva Ø6.3x36mm	37
3	Cerradura de la leva Ø15x9mm	37
4	Cabeza Redondo Ø3x12mm	42
5	Tornillo Ø3x15mm	16
6	Chapas de metal 10X17MM	7
7	Bisagra	4
8	Bisagra	4
9	Tapa de la leva Ø18x8.5mm	4
10	Tapa de la leva Ø18x7mm	12

PASO 6	Ate una particion izquierda (S), una partición derecha (T) y una partición del centro (R) al tablero fijo (J) con seis cerraduras de la leva (3) como mostrado.
PASO 7	Inserte diez clavijas de madera (1) en los agujeros de los paneles laterales (O&P) como mostrado. Atornille cuatro pernos de la leva (2) en los agujeros de los paneles laterales (O&P) como mostrado.
PASO 8	Ate dos paneles del lado (O&P) a los tableros fijos (J&K) y el barra inferior (N) con cuatro cerraduras de la leva (3) como mostrado.
PASO 9	Inserte cinco clavijas de madera (1) en los agujeros del panel de la cima (yo) como mostrado. Atornille diez pernos de la leva (2) en los agujeros del panel de la cima (yo) como mostrado.
PASO 10	Ate un panel de la cima (I) a los paneles laterales (O&P) y las particiones (S&R&T) con diez cerraduras de la leva (3) como mostrado.

<p>PASO 11 Atornille dos paneles traseros (L&M) al marco con treinta y cinco tornillo (4) como mostrado.</p>
<p>PASO 12 Atornille dos paneles traseros (L&M) al marco con siete tornillos (4) y siete chapa de metal (6) como mostrado.</p>
<p>PASO 13 Ate dos bisagras (7) a la puerta de madera (U) con ocho tornillos (5) como mostrado. Ate dos bisagras (8) al puerta de vaso (V) con ocho tornillos (5) como mostrado.</p>
<p>PASO 14 Ate dos puertas de madera (U) a los paneles laterales (O&P) como mostrado. Ate dos puertas de vaso (V) a las particiones (S&T) como mostrado.</p>

PASO 15
Inserte dos clavijas de madera (1) en los agujeros del panel de cima de retorno como mostrado.
Atornille cinco pernos de la leva (2) en los agujeros del panel de cima de retorno como mostrado.

PASO 16
Fije la conejera al retorno con cinco cerraduras de la leva (3) y cuatro tapas de leva (9) como mostrado.

Limites de carga la página:

Llame a el numero gratuito para asistencia o visitenos al correo electronico:

1-800-489-3351 www.altarafurniture.com

Limpie el producto con su favorito limpiador de muebles con un trapo suave. NO UTILISE quimicos asperos o limpiadores agresivos. Mueva sus muebles con cuidado con dos personas. Levante y mueva el mueble nunca empuje o jale. No deje niños subir o jugar en el mueble. Si no sigue estos avisos puede resultar en un dano muy severo. Este mueble esta disenado para soportar la carga maxima como lo muestra la foto. Exidiendo estos limites de cargo puede causar danos como doblamiento, desalinarlo, y el producto puede caerse o causar danos severos. Partes adicionales estan disponibles por un precio nomino.